

# FS-BLAKE Insert compatible with Boonlake®

## Assembly Instructions

The package contains 3 sheets: one double and one single sheet.  
 After assembly the trays are put in up to two layers in the original game box.  
 Ordinary PVA glue is required when assembling each tray.  
 Please make sure you dry-assemble each tray correctly before gluing it together.  
 The parts marked in grey should be disposed of.  
 Please check [www.foldedspace.com](http://www.foldedspace.com) for general assembly tips.

## FS-BLAKE

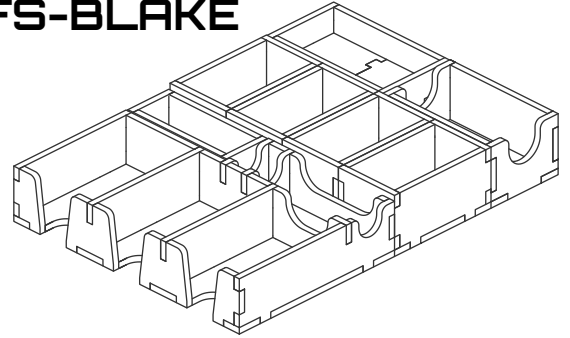

**Sheet A1**

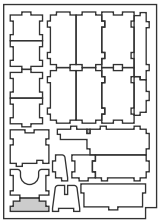

**Sheet A2**

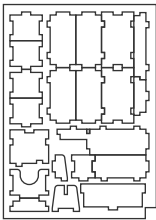

**Sheet B**

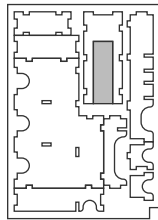

### Tray 1

Sheet A1, A2 Sheet B

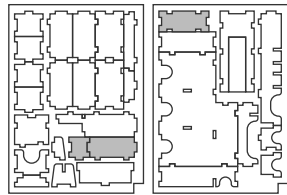

Step 1

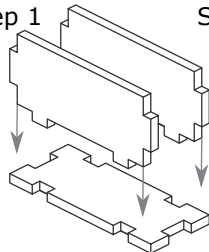

Step 2

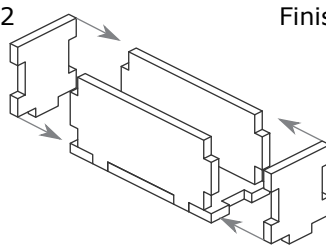

Finished tray

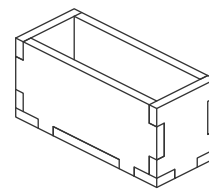

### Tray 2a, 2b, 2c, 2d (the trays are identical)

Sheet A1, A2

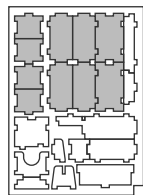

Step 1

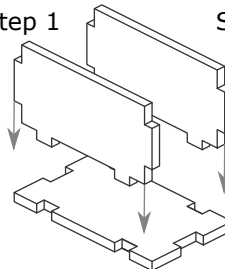

Step 2

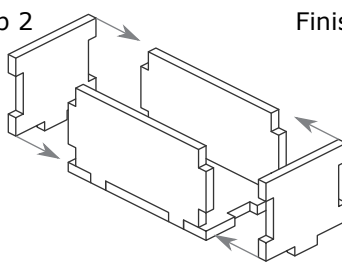

Finished tray

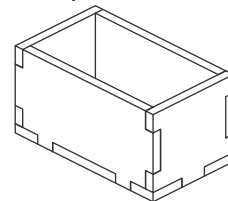

### Tray 3

Sheet A1, A2

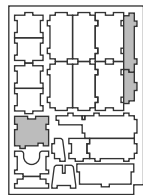

Step 1

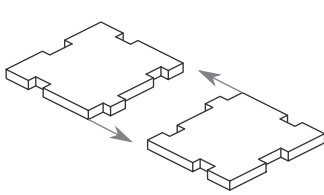

Step 2

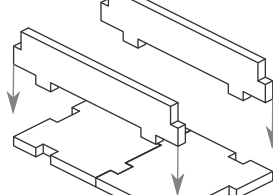

Step 3

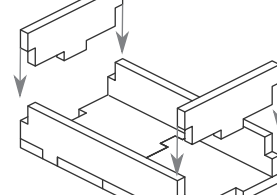

Finished tray

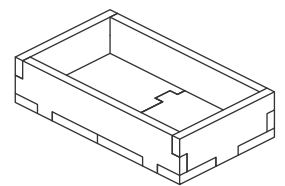

### Tray 4

Sheet A1, A2 Sheet B

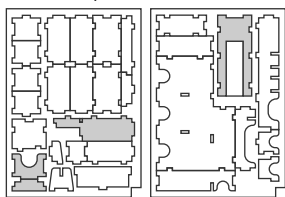

Step 1

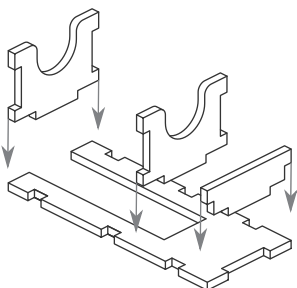

Step 2

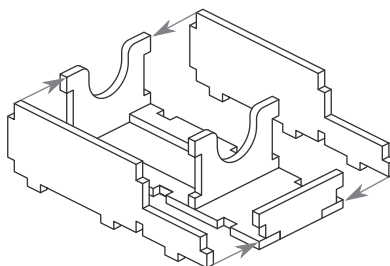

Finished tray

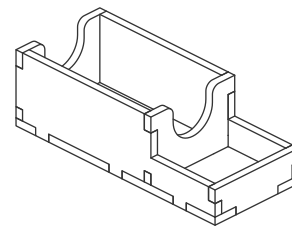

### Tray 5

Sheet A1, A2 Sheet B

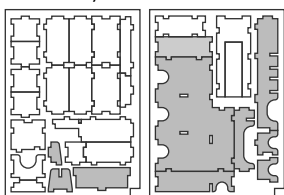

Step 1

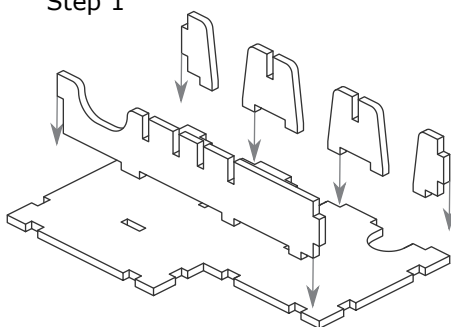

Step 2

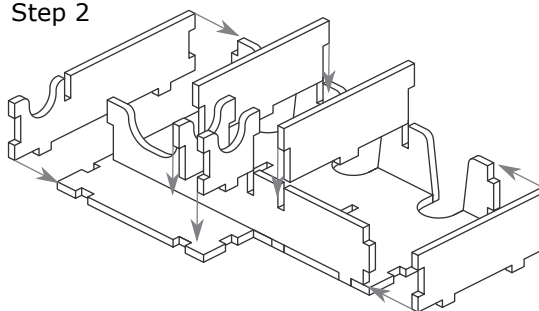

Step 3

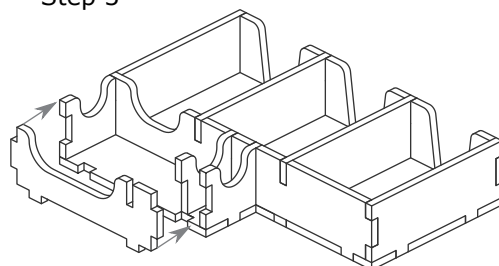

Finished tray

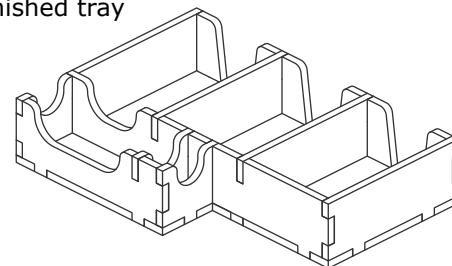

## FS-BLAKE

Trays 2a, 2b, 2c, 2d  
Trays 1, 5

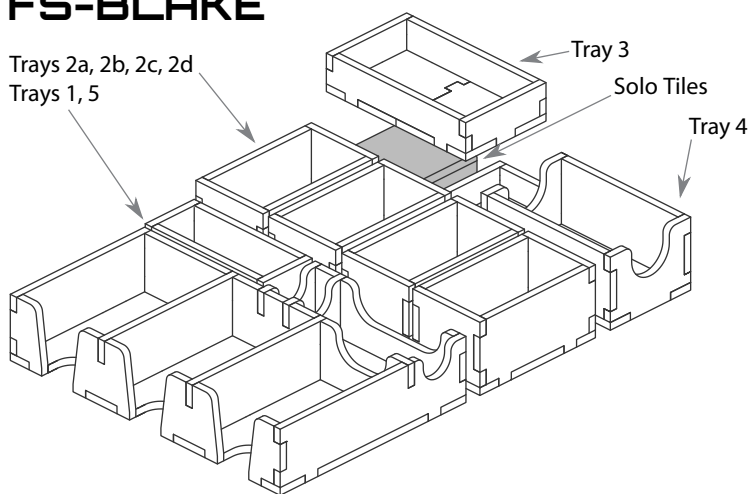

Please check [www.foldedspace.com](http://www.foldedspace.com) for photos of this insert in use.

### Tray legend:

- Tray 1 - lever tokens
- Tray 2a, b, c, d - player pieces
- Tray 3 - value 1 & 5 coins
- Tray 4 - building tiles, region markers, starting player token, and vases
- Tray 5 - project cards, scoring tiles, and value 20 coins

Note: the action board is placed on top of tray 1 and 5, with the actions strips placed in the recessed board.