

FS-LCG insert

compatible with Living Card Games®,

such as Warhammer Invasion®, Android Netrunner®, Star Wars®, and many others



Assembly Instructions

The package contains 4 identical sheets. FS-LCG insert has two versions.

Each tray is doubled.

After assembly, trays 4 and 5 should be placed in the game box and not removed. The other trays are meant to be removed and used in game play.

Ordinary PVA glue is required when assembling each tray, for extra strength.

Please make sure you dry-assemble each tray correctly before gluing it together.

Please check www.foldedspace.net for general assembly tips.

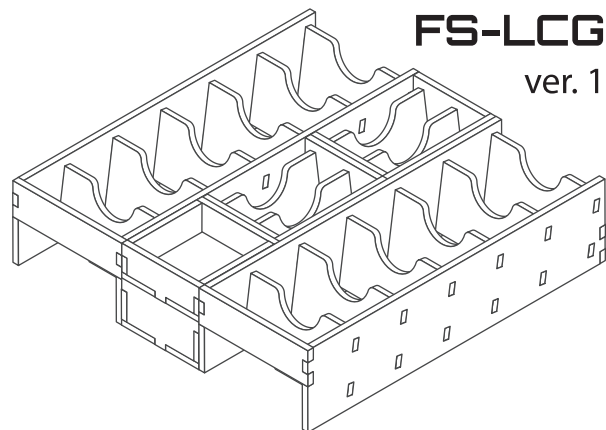

FS-LCG
ver. 1

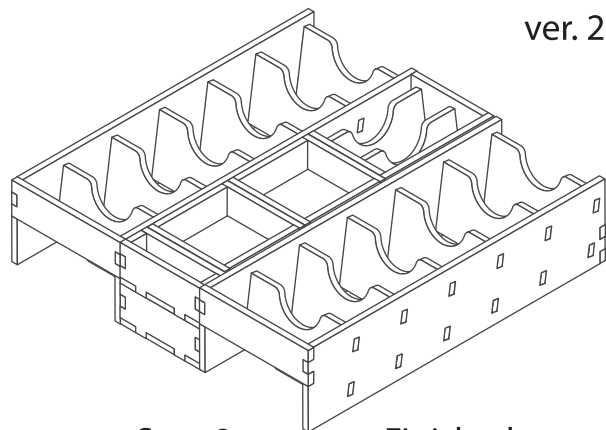

ver. 2

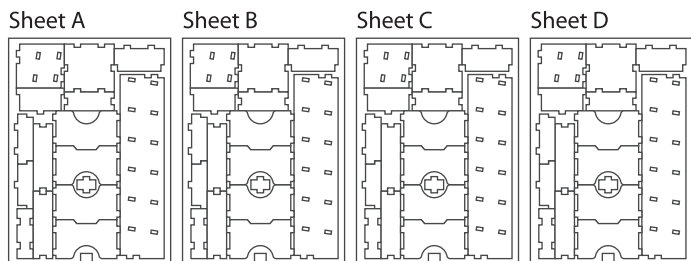

Tray 1a & 1b (the trays are identical)

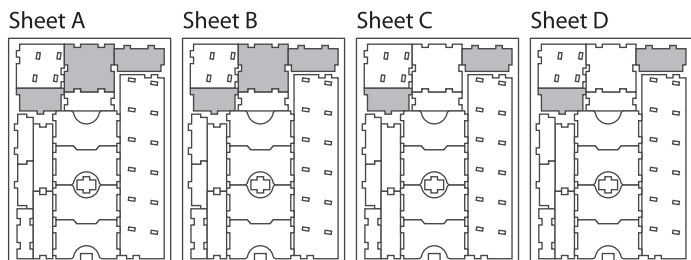

Tray 2a & 2b (the trays are identical)

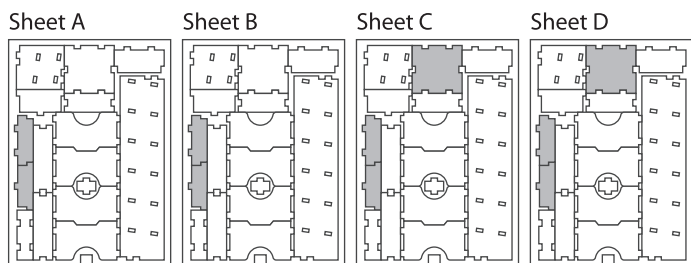

Tray 3a & 3b (the trays are identical)

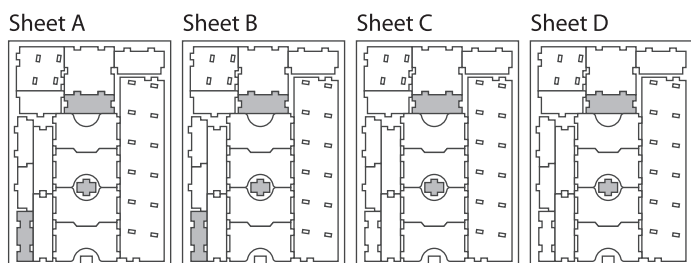

Step 1

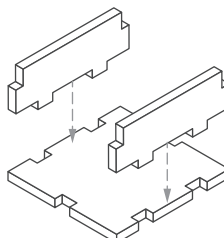

Step 2

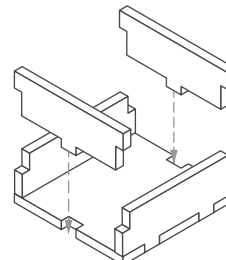

Finished tray

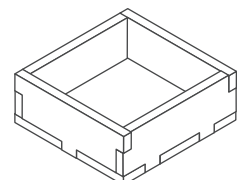

To assemble repeat steps for Tray 1.

Finished tray

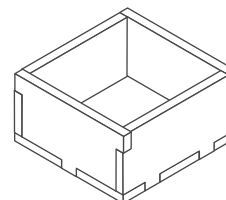

Step 1

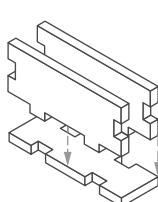

Step 2

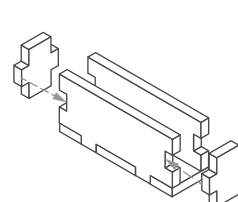

Finished tray

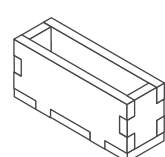

Tray 4a & 4b (the trays are identical)

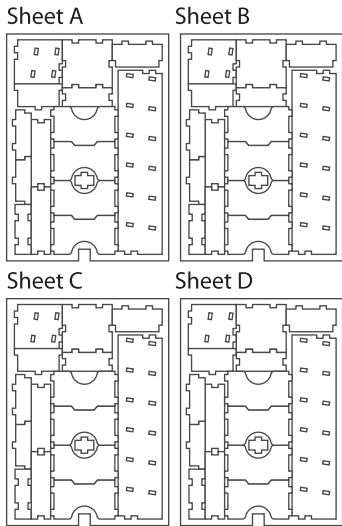

Step 1

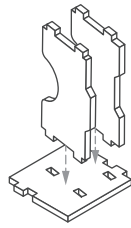

Step 2

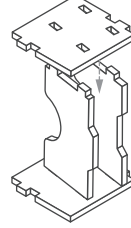

Step 3

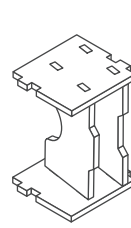

Step 4

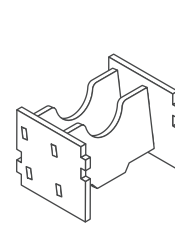

Step 5

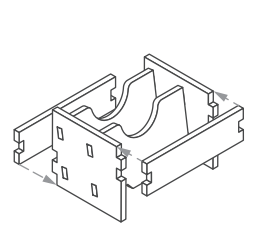

Finished tray

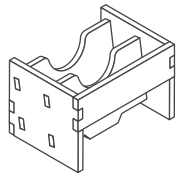

Note on Tray 4 and Tray 5:
No glue is needed in steps 1 to 4.

Tray 5a & 5b (the trays are identical)

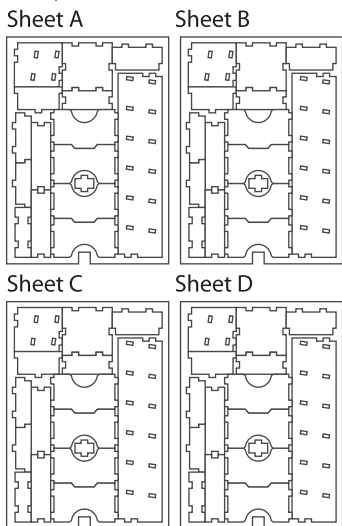

Step 1

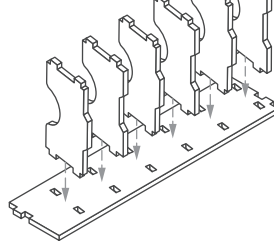

Step 2

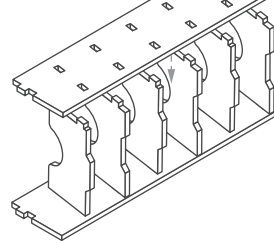

Step 3

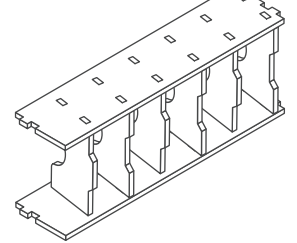

Step 4

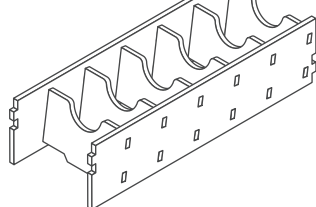

Step 5

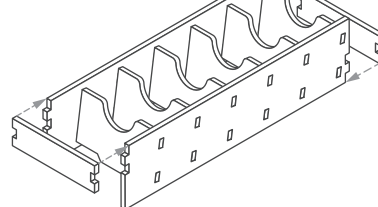

Finished tray

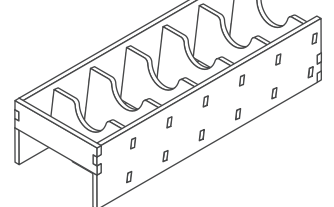

FS-LCG

ver. 1

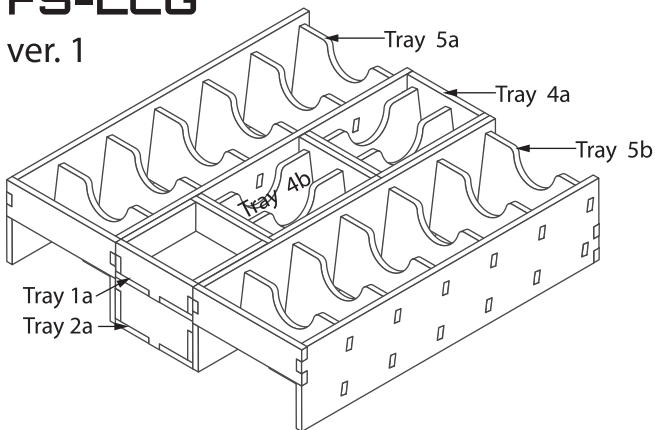

FS-LCG

ver. 2

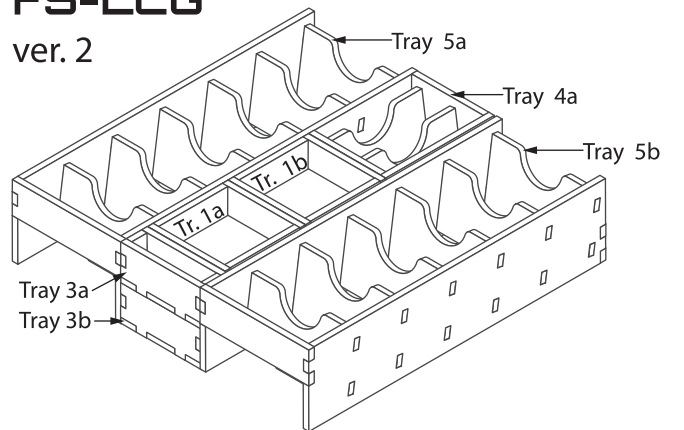

Ver. 1 spare trays:

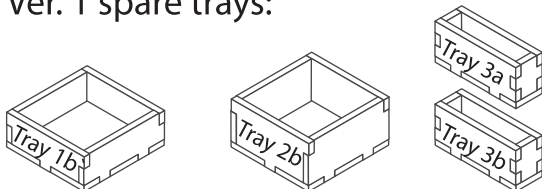

Ver. 2 spare trays:

